

SPECIFICATIONS

PXle-5622

150 MS/s, 16-Bit PXI IF Digitizer

These specifications apply to the PXIe-5622 with 64 MB and 256 MB of memory.



Hot Surface If the PXIe-5622 has been in use, it may exceed safe handling temperatures and cause burns. Allow the PXIe-5622 to cool before removing it from the chassis.



Caution Do not operate the PXIe-5622 in a manner not specified in this document. Product misuse can result in a hazard. You can compromise the safety protection built into the product if the product is damaged in any way. If the product is damaged, return it to NI for repair.

Contents

Definitions and Conditions.....	2
Vertical.....	3
Analog Input (IF IN).....	3
Accuracy.....	3
Bandwidth and Frequency Response.....	4
Spectral Characteristics.....	7
Noise.....	8
Horizontal.....	11
Sample Clock.....	11
Onboard Clock (Internal VCXO).....	11
Phase-Locked Loop (PLL) External Reference Clock	11
External Sample Clock.....	12
CLK IN (Sample Clock and Reference Clock Input, Front Panel Connector)	12
CLK OUT (Sample Clock and Reference Clock Output, Front Panel Connector)	12
PFI 1 (Programmable Function Interface)	12
Trigger.....	12
TClk Specifications.....	13
PXIe-5622 TClk Specifications.....	14
Waveform Specifications.....	14
Onboard Signal Processing (OSP).....	15
OSP Digital Gain and Offset.....	16
OSP Numerically-Controlled Oscillator (NCO).....	17
OSP Digital Performance.....	17
OSP IF Demodulation Typical Performance: Modulation Error Ratio (MER).....	18
Calibration.....	19

Software.....	19
Driver Software.....	19
Application Software.....	19
Interactive Soft Front Panel and Configuration.....	19
Power.....	19
Physical Characteristics.....	20
Environment.....	20
Operating Environment.....	20
Storage Environment.....	20
Shock and Vibration.....	20
Compliance and Certifications.....	21
Safety.....	21
Electromagnetic Compatibility.....	21
CE Compliance	22
Online Product Certification.....	22
Environmental Management.....	22

Definitions and Conditions

Specifications are subject to change without notice. For the most recent PXIe-5622 specifications, visit ni.com/manuals. Unless otherwise noted, the following conditions were used for each specification:

- Direct path filter setting enabled
- Sample clock set to internal 150 MS/s, unlocked
- 1 V vertical range

Specifications describe the warranted, traceable performance of the device over an ambient temperature range of 0 °C to 55 °C and include guardband for measurement uncertainty, unless otherwise noted. Specifications are valid under the following conditions unless otherwise noted:

- The PXIe-5622 module is warmed up for 15 minutes at ambient temperature.
- Calibration cycle is maintained.
- NI-SCOPE self-calibration performed after device temperature is stable.
- The PXI Express chassis fan speed is set to HIGH, the foam fan filters are removed if present, and the empty slots contain PXI chassis slot blockers and filler panels. For more information about cooling, refer to the *Maintain Forced-Air Cooling Note to Users* available at ni.com/manuals.
- External calibration is performed at 23 °C ± 3 °C.

Typical Specifications are unwarranted values that describe the expected performance of the device over ambient temperature ranges of 23 °C ± 5 °C with a 90% confidence level.

Characteristics (or supplemental information) describe basic functions and attributes of the device established by design.

Data in this document are Specifications unless otherwise noted.

To access PXIe-5622 documentation, including the *PXIe-5622 Getting Started Guide*, go to **Start»All Programs»National Instruments»NI-SCOPE»NI-SCOPE Documentation**.

Vertical

Analog Input (IF IN)

Number of channels	One (IF IN)
Input impedance	50 Ω , characteristic
Input return loss	<-15 dB, 5 MHz to 300 MHz, typical
Input coupling	AC, GND
Full scale (FS) input voltage range (Vpk-pk) ¹	0.7 V (+1 dBm), 1 V (+4 dBm), 1.4 V (+7 dBm)
Maximum voltage input overload (Vpk-pk)	6.3 V (+20 dBm)

Accuracy

Resolution	16-bit
Absolute amplitude accuracy, at center frequency of specified bands, valid for all input ranges ²	
Bandpass Path (187.5 MHz)	< \pm 0.5 dB
Direct Path (53 MHz)	< \pm 0.4 dB
Absolute amplitude accuracy, at center frequency of specified bands, valid for all input ranges ³	
Bandpass Path (187.5 MHz)	< \pm 0.3 dB, typical
Direct Path (53 MHz)	< \pm 0.25 dB, typical
Temperature stability, maximum drift of ± 2 °C from last self-calibration, valid for all input ranges	
Bandpass Path (187.5 MHz)	<0.01 dB/°C
Direct Path (53 MHz)	<0.02 dB/°C

Absolute Amplitude Accuracy Examples at 40 °C in the Bandpass Path

Amplitude accuracy specification: $0.5 + 0.01 \times (40 - 23) = \pm 0.67$ dB

Amplitude accuracy, typical: $0.3 + 0.01 \times (40 - 23) = \pm 0.47$ dB

¹ Dither enabled. Can overrange up to 3 dB with Dither disabled.

² Valid over 23 °C \pm 5 °C. Maximum drift of ± 2 °C from last self-calibration.

³ Valid over 23 °C \pm 5 °C. Maximum drift of ± 2 °C from last self-calibration.

Bandwidth and Frequency Response

Bandwidth (-3 dB), bandwidth of unequalized response

Bandpass path (187.5 MHz)	50 MHz, centered at 187.5 MHz, 3rd Nyquist zone, typical
Direct path (53 MHz)	3 MHz to 250 MHz, typical
Dither signal, frequency range ⁴	100 kHz to 12 MHz, typical

Figure 1. Equalized Amplitude Response (Bandpass Path), Using Calibration Data

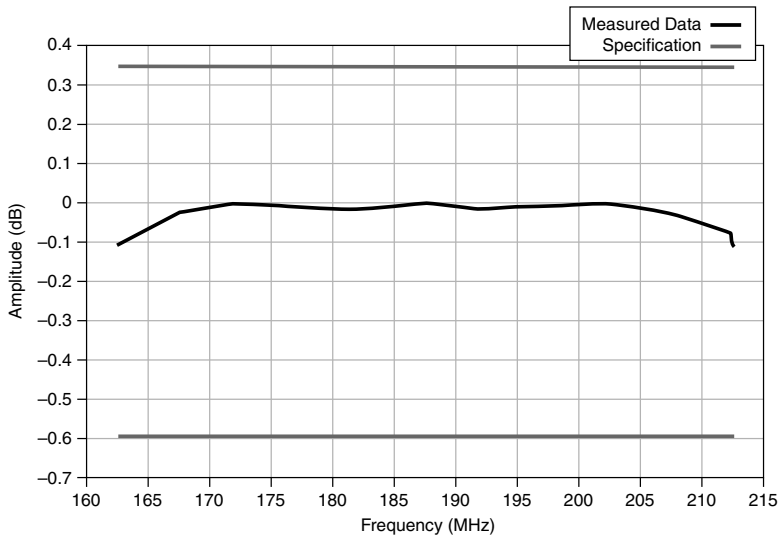

⁴ Dither is disabled by default in NI-SCOPE. To enable dithering, refer to the [NI High-Speed Digitizers Help](#).

Figure 2. Equalized Amplitude Response (Direct Path), Using Calibration Data

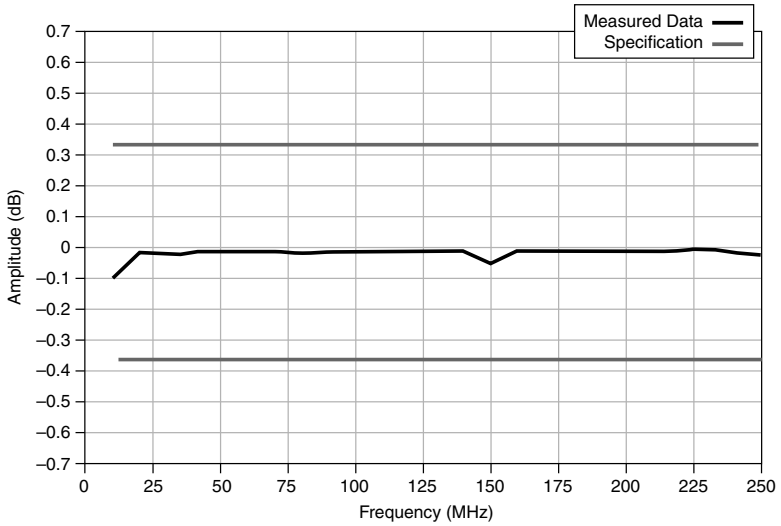

Note The Direct Path Equalized Amplitude Response shown above is a composite plot of multiple segments of 40 MHz span each.

Figure 3. Unequalized Amplitude Response (Bandpass Path)

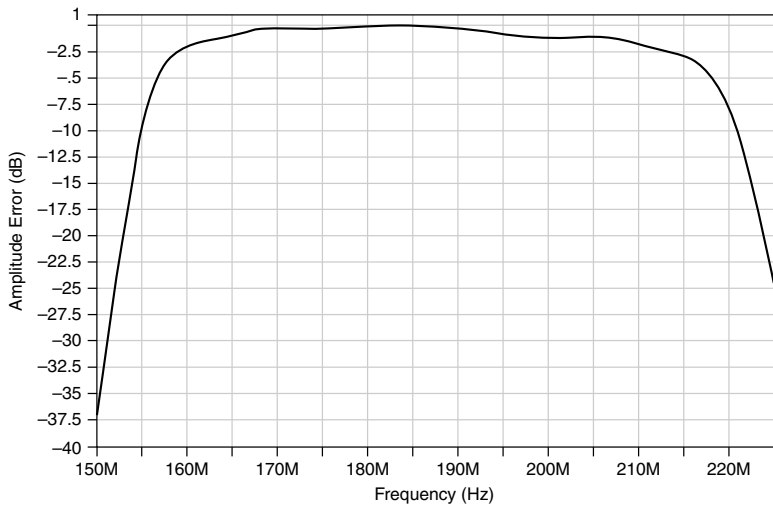

Figure 4. Unequalized Amplitude Response (Direct Path)

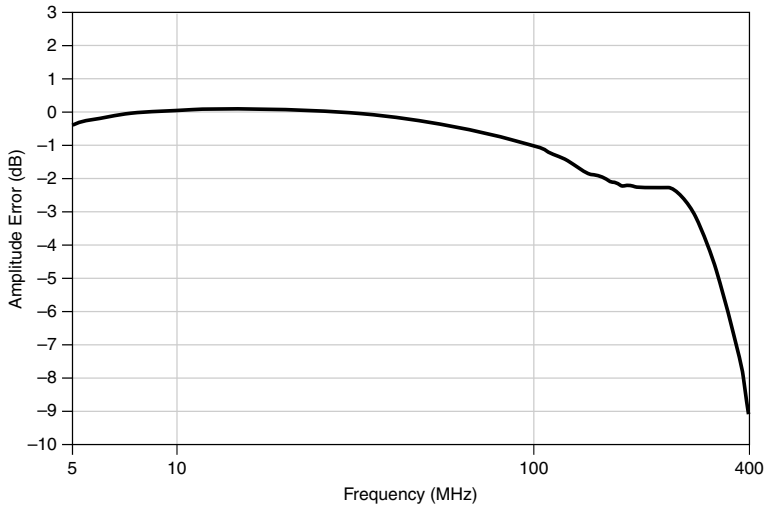

Table 1. Passband Amplitude Flatness

	Bandpass Path	Direct Path
Passband amplitude flatness, valid for 1 V range	<+0.35, -0.6 dB (equalized) ⁵ 187.5 MHz ±25 MHz	<±0.35 dB (equalized) 53 MHz ± 19 MHz
		< ±0.6 dB (equalized) 10 MHz to 250 MHz (referenced to 100 MHz)
Passband amplitude flatness, valid for all ranges, typical	<+0.25, -0.4 dB (equalized) <+0.7, -3.5 dB (unequalized) 187.5 MHz ±25 MHz	< ±0.25 dB (equalized)
		< ±0.6 dB (unequalized) 53 MHz ±19 MHz
		<±0.5 dB (equalized) <±1.8 dB (unequalized) 10 to 250 MHz (referenced to 100 MHz)

⁵ Equalization requires using the Digital Filter Design Toolkit to compute equalization filter coefficients. This software is not included with the NI-SCOPE driver.

Table 2. Passband phase linearity, valid for all input ranges, after equalization, typical

Bandwidth	Bandpass Path Phase	Direct Path Phase
10 MHz	$\pm 0.5^\circ$	$\pm 0.5^\circ$
20 MHz	$\pm 1^\circ$	$\pm 1^\circ$
40 MHz	$\pm 1.75^\circ$	n/a
50 MHz	$\pm 2.5^\circ$	

Spectral Characteristics⁶

Spurious-free dynamic range with harmonics (SFDR), for input signal with levels from -1 dBFS to -10 dBFS

Bandpass path (187.5 MHz)	<-76.5 dBc, typical
Direct path (53 MHz)	<-73 dBc, typical
Total harmonic distortion (THD), includes 2nd through 5th harmonics	
Bandpass path (187.5 MHz)	<-76 dBc, typical
Direct path (53 MHz)	<-71 dBc, typical
Intermodulation distortion (IMD), two tones 1 MHz apart, down to -10 dBFS level	
Bandpass path (187.5 MHz)	<-74 dBc, typical
Direct path (53 MHz)	<-73 dBc, typical

⁶ +3 dBm total power at 1 V range, Dither ON

Figure 5. Single Tone Spectrum, 5.5 dBm, Bandpass Path, 4 kHz RBW

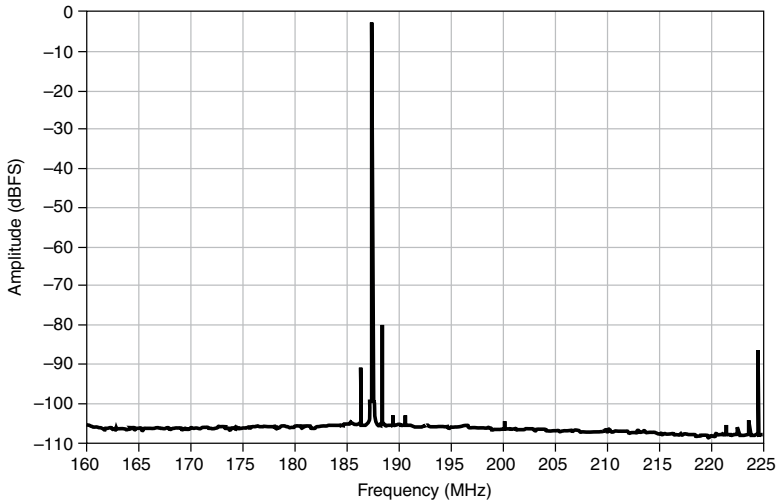
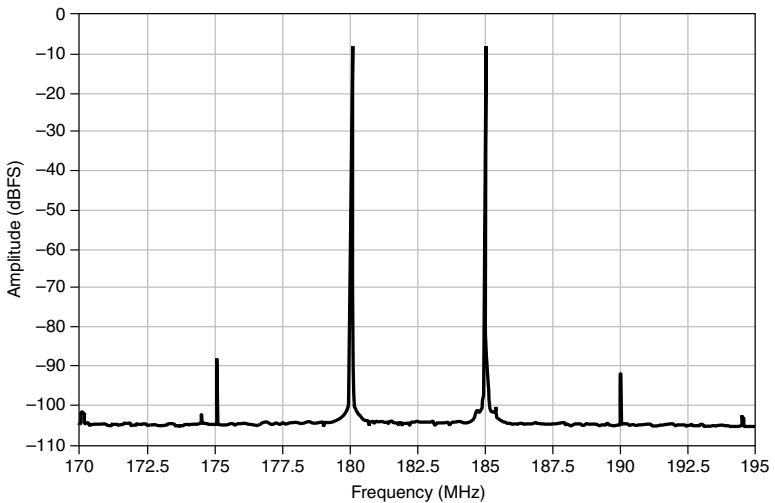

Figure 6. Two-Tone Spectrum, 2 dBm Each, Bandpass Path, 4 kHz RBW



Noise

Full bandwidth Signal-to-Noise Ratio (SNR), internal VCXO at 150 MS/s

Bandpass path (187.5 MHz)	>66.5 dB, typical
Direct path (53 MHz)	>67 dB, typical

4.28 MHz bandwidth SNR, DDC enabled, at 5.35 MS/s sample rate

Bandpass path (187.5 MHz)	>71.5 dB, typical
Direct path (53 MHz)	>73 dB, typical

Table 3. SSB Phase Noise, Internal VCXO, Unlocked

	Bandwidth	Bandpass path (187.5 MHz)	Direct path (53 MHz)
SSB phase noise	100 Hz	<-80 dBc/Hz	<-90 dBc/Hz
	1 kHz	<-117 dBc/Hz	<-128 dBc/Hz
	10 kHz and above	<-134 dBc/Hz	<-141 dBc/Hz
SSB phase noise, typical	100 Hz	<-83 dBc/Hz	<-94 dBc/Hz
	1 kHz	<-120 dBc/Hz	<-132 dBc/Hz
	10 kHz and above	<-140 dBc/Hz	<-144 dBc/Hz

Table 4. Average noise density

	Range	Value
Average noise density ⁷	0.7 V/+1 dBm	<-146 dBm/Hz
	1 V/+4 dBm	<-143 dBm/Hz
	1.4 V/+7 dBm	<-140 dBm/Hz
Average noise density, typical ⁸	0.7 V/+1 dBm	<-149 dBm/Hz
	1 V/+4 dBm	<-146 dBm/Hz
	1.4 V/+7 dBm	<-143 dBm/Hz

⁷ Verified using a 50 Ω terminator connected to input; valid for all filter paths.

⁸ Verified using a 50 Ω terminator connected to input; valid for all filter paths.

Figure 7. Measured Phase Noise at 187 MHz, Bandpass Path, Signal Level = 3 dBm, Typical

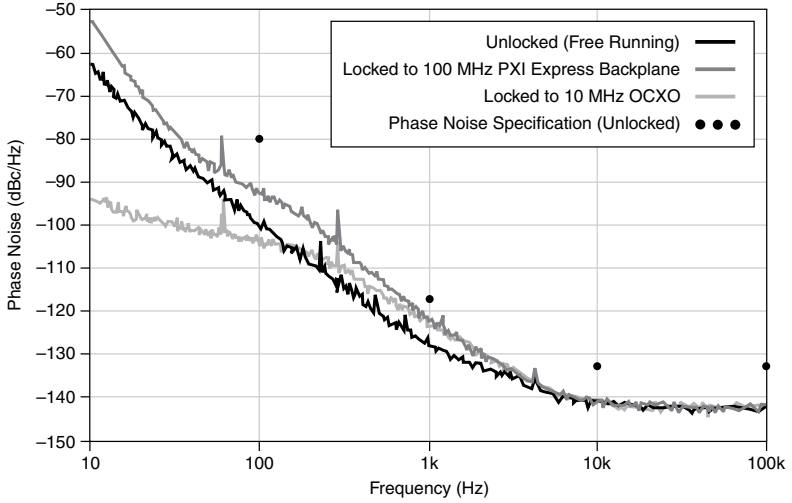
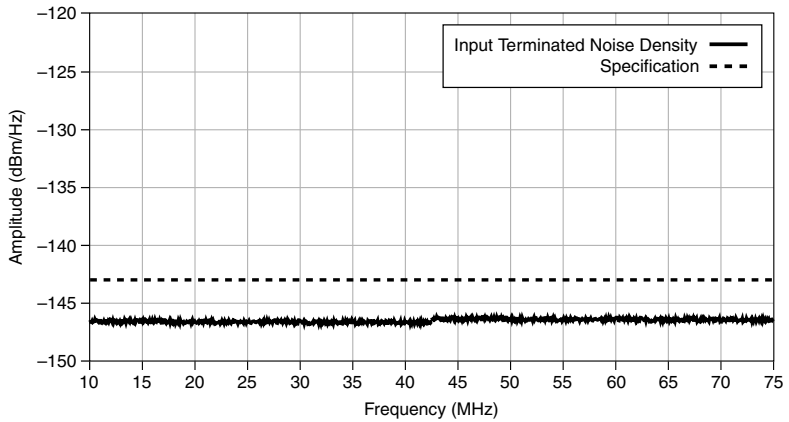

Figure 8. Noise Density (Direct Path), Typical



Horizontal

Sample Clock

Sample clock sources

Internal	VCXO (can be free running or locked to a reference clock)
External	CLK IN (front panel connector)

Onboard Clock (Internal VCXO)

Sample rate⁹ 150 MS/s with decimation by N

Accuracy $\pm 5.0 \times 10^{-6}$, typical

Accuracy over temperature $\pm 12 \times 10^{-6}$, typical

SSB phase noise of 150 MHz Sample Clock when exported to CLK OUT¹⁰

100 Hz < -90 dBc/Hz, typical

1 kHz < -130 dBc/Hz, typical

10 kHz < -140 dBc/Hz, typical

100 kHz and above < -150 dBc/Hz, typical

Phase-Locked Loop (PLL) External Reference Clock

Reference Clock sources (used to phase lock onboard VCXO) CLK IN (front panel connector), PXIe 100 MHz (PXIe backplane)

Sample Clock delay range (delay relative to Reference Clock when VCXO is locked) ± 1 Sample Clock period

Sample Clock delay resolution (delay relative to Reference Clock when VCXO is locked) ≤ 4 ps

Reference Clock frequency range 1 MHz to 100 MHz, in 1 MHz increments

Reference Clock frequency accuracy¹¹ $\pm 25 \times 10^{-6}$

⁹ Refer to the *Onboard signal processing (OSP)* section for possible N values (with and without fractional resampling). Non-OSP decimation does not protect the acquired data from undersampling aliasing. Non-OSP decimation and OSP decimation are mutually exclusive.

¹⁰ Internal VCXO, unlocked.

¹¹ Refer to your chassis documentation to ensure it meets this requirement.

Reference Clock duty cycle tolerance	45% to 55%, typical
Reference Clock export ports	CLK OUT (front panel connector)

External Sample Clock

Frequency range	20 MHz to 150 MHz
Duty cycle tolerance	45% to 55%, typical
Export ports	CLK OUT (front panel connector)

CLK IN (Sample Clock and Reference Clock Input, Front Panel Connector)

Input impedance	50 Ω , typical
Coupling	AC
Amplitude	
Sine wave (Vpk-pk)	0.63 V to 2.8 V (0 to +13 dBm)
Square wave (Vpk-pk)	0.25 V to 2.8 V
Maximum input overload (Vpk-pk)	6.3 V (+20 dBm)

CLK OUT (Sample Clock and Reference Clock Output, Front Panel Connector)

Output impedance	50 Ω , typical
Coupling	AC
Amplitude	
50 Ω load	> +10 dBm, typical
1 k Ω load, square wave (Vpk-pk)	> 2 V, typical

PFI 1 (Programmable Function Interface)

PFI 1 (programmable function interface) direction	Bi-directional
---	----------------

Trigger

Trigger types	Digital
---------------	---------

As an input (trigger)

Destinations	Start Trigger (Acquisition Arm) Reference (Stop) Trigger Arm Reference Trigger Advance Trigger
Input impedance	150 k Ω , characteristic
Range	0 to 5 V, TTL compatible
Maximum input overload	-3.5 V to +8 V, continuous
Maximum frequency	20 MHz
Minimum trigger width	>25 ns

As an output (event)

Sources	Start Trigger (Acquisition Arm) Reference (Stop) Trigger End of Record Done (End of Acquisition)
Output impedance	50 Ω , characteristic
Logic type	3.3 V LVTTTL
Maximum drive current	\pm 12 mA
Maximum frequency	25 MHz

TClk Specifications

You can use the NI TClk synchronization method and the NI-TClk driver to align the Sample clocks on any number of supported devices, in one or more chassis. For more information about TClk synchronization, refer to the *NI-TClk Synchronization Help*, which is located within the *NI High-Speed Digitizers Help*. For other configurations, including multichassis systems, contact NI Technical Support at ni.com/support.

PXIe-5622 TCk Specifications

- Specifications measured in an NI PXIe-1062Q chassis.
- All parameters set to identical values for each PXIe-5622.
- Sample Clock set to 150 MS/s and all filters are disabled.



Note Although you can use NI-TCk to synchronize non-identical devices, these specifications apply only to synchronizing identical devices.

Intermodule synchronization using NI-TCk for identical devices

Skew (caused by clock and analog path delay differences; no manual adjustment performed)	≤500 ps, typical
Average skew after manual adjustment ¹²	≤4 ps, typical
Sample Clock delay/adjustment resolution	≤4 ps, typical

Waveform Specifications

Onboard memory sizes¹³

64 MB per channel option	32 megasamples per channel
256 MB per channel option	128 megasamples per channel

Allocated onboard memory per record

Real data	$(Record\ Length \times 2\ bytes/S) + 480\ bytes$, rounded up to the next multiple of 128 bytes (minimum 512 bytes) ¹⁴
Complex data	$(Record\ Length \times 4\ bytes/S) + 960\ bytes$, rounded up to the next multiple of 128 bytes (minimum 512 bytes)
Minimum record length	1 sample
Number of pretrigger samples, single-record mode and multiple-record mode	Zero up to full record length

¹² For information about manual adjustment, refer to the *Synchronization Repeatability Optimization* topic in the *NI-TCk Synchronization Help*; for additional help with the adjustment process, contact NI technical support at ni.com/support.

¹³ Assumes 2-byte samples. In Complex data processing mode (only available when using onboard signal processing), each sample is 4 bytes, so this number is halved.

¹⁴ *Record length* refers to the number of samples, or data points, the NI-SCOPE device acquires for each channel in a single acquisition.

Number of posttrigger samples, single-record mode and multiple-record mode	Zero up to full record length
Maximum number of records in onboard memory ¹⁵	100,000

Onboard Signal Processing (OSP)

Figure 9. PXIe-5622 Onboard Signal Processing Block Diagram

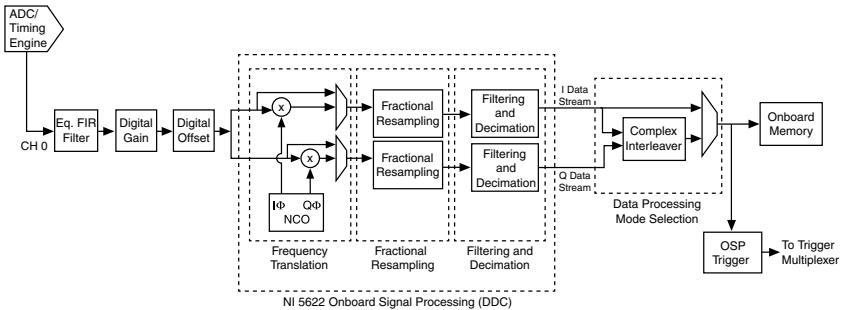

Note To use onboard signal processing (OSP) on the PXIe-5622, set the DDC Enabled property/attribute to TRUE.

The following OSP operations are available:

- Send one IF signal to CH 0 and perform quadrature downconversion on the signal (complex data is returned).
- Send a signal to CH 0 and perform alias-protected decimation (real data is returned).
- Send a signal to CH 0 and perform real downconversion on the signal (real data is returned).

Number of digital downconverters (DDCs)	One
Data processing modes	Real (I path only); Complex (IQ)
OSP decimation (protects acquired data from high-frequency aliasing within the ADC Nyquist zone) ¹⁶	
Range	1, 2, 4, 6, 8, 10
Multiples of 4 range	12 to 4,096
Multiples of 8 range	4,096 to 8,192

¹⁵ It is possible to exceed this number if you fetch records while acquiring data. For more information, refer to the [NI High-Speed Digitizers Help](#).

¹⁶ Non-OSP decimation does not protect against high-frequency aliasing. Non-OSP decimation and OSP decimation are mutually exclusive.

Multiples of 16 range	8,192 to 16,384
Fractional resampling enabled	2 to 16,384 to 48 bits of precision
Sample rate range, OSP enabled ¹⁷	
Internal sample clock timebase	9.155 kS/s to 75 MS/s with fractional resampling; or to 150 MS/s without fractional resampling
External sample clock OSP decimation factor ¹⁸	Sample clock timebase/OSP decimation
Bandwidth ¹⁹	
Real flat bandwidth	$0.4 \times \text{Sample Rate}$
Complex flat bandwidth	$0.8 \times \text{Sample Rate}$

Complex Flat Bandwidth Example

Complex bandwidth is 60 MHz with a complex sample rate of 75 MS/s.

Using a decimation rate of 1 (sample rate of 150 MS/s with internal clock) bypasses the filters in the OSP block.

OSP Digital Gain and Offset

Digital gain and offset resolution	18 bits
Digital gain range	$\pm 1.5 \times \text{ADC Data} $ ²⁰
Digital offset, applied after digital gain	$(-0.4 \times \text{Vertical Range})$ to $(+0.4 \times \text{Vertical Range})$
Output ²¹	$(\text{ADC Data} \times \text{Digital Gain}) + \text{Digital Offset}$

¹⁷ For sample rates less than 9.155 kS/s, use an external sample clock or perform additional software decimation.

¹⁸ Fractional resampling not available.

¹⁹ Using a decimation rate of 1 (sample rate of 150 MS/s with internal clock) bypasses the filters in the OSP block.

²⁰ Gain <1 attenuates user data

²¹ $(-0.5 \times \text{Vertical Range}) \leq \text{Output} \leq (+0.5 \times \text{Vertical Range})$

OSP Numerically-Controlled Oscillator (NCO)

Frequency range²²

Internal sample clock timebase	0 MHz to 75 MHz
External sample clock timebase	0 Hz to $(0.5 \times \text{Sample Clock Timebase})$

Frequency resolution

Internal sample clock timebase	533 nHz
External sample clock timebase	$\text{Sample Clock Timebase} / 2^{48}$

I and Q phase resolution	0.0055°
--------------------------	---------

OSP Digital Performance

Maximum NCO spur	< -100 dBFS
Decimating filter passband ripple, passband is from 0 to $(0.4 \times IQ \text{ Rate})$	< 0.1 dB
Decimating filter Out-of-Band suppression, stopband suppression from $(0.6 \times IQ \text{ Rate})$	> 80 dB

²² Undersampling can be used for carrier frequencies >75 MHz.

OSP IF Demodulation Typical Performance: Modulation Error Ratio (MER)

	Bandpass path carrier frequency: 187.5 MHz (signal source: NI PXIe-5673)		Direct path carrier frequency: 20 MHz (signal source: NI PXI-5441)	
	Internal Reference Clocks (source and receiver unlocked to any external reference)	PXI chassis Reference Clocks (source and receiver locked to PXIe 100 MHz or PXI 10 MHz chassis backplane clock)	Internal Reference Clocks (source and receiver unlocked to any external reference)	PXI chassis Reference Clocks (source and receiver locked to PXIe 100 MHz or PXI 10 MHz chassis backplane clock)
GSM physical layer, typical. ²³	50 dB	59 dB	48 dB	62 dB ²⁴
W-CDMA physical layer, typical. ²⁵	47 dB	50 dB	39 dB	58 dB
DVB physical layer, typical. ²⁶	46 dB	48 dB	40 dB	56 dB
20 MSymbols/s QAM, typical. ²⁷	43 dB	44 dB	37 dB	49 dB
26 MSymbols/s QAM, typical. ²⁸	39 dB	37 dB	36 dB	40 dB
34 MSymbols/s QAM, typical. ²⁹	38 dB	37 dB	38 dB	37 dB

²³ MSK modulation, 270.833 kSymbols/s, 1024 symbols, gaussian, BT = 0.3.

²⁴ In this case, the direct path carrier frequency is 35 MHz using the NI PXIe-5450 as the source.

²⁵ QPSK modulation, 3.84 MSymbols/s, 1024 symbols, root raised cosine, alpha = 0.22.

²⁶ 32 QAM modulation, 6.92 MSymbols/s, 1024 symbols, root raised cosine, alpha = 0.15.

²⁷ 64 QAM modulation, 20 MSymbols/s, 1024 symbols, root raised cosine, alpha = 0.15.

²⁸ 64 QAM modulation, 26.09 MSymbols/s, 1024 symbols, root raised cosine, alpha = 0.15.

²⁹ 64 QAM modulation, 34.78 MSymbols/s, 1024 symbols, root raised cosine, alpha = 0.15.

Calibration

Self-calibration	Calibrates absolute amplitude accuracy.
External calibration	Calibrates absolute and relative (flatness) amplitude accuracy, VCXO accuracy.
External calibration interval	1 year
Warm-up time	15 minutes

Software

Driver Software

Driver support for this device was first available in NI-SCOPE 3.5.

NI-SCOPE is an IVI-compliant driver that allows you to configure, control, and calibrate the PXIe-5622. NI-SCOPE provides application programming interfaces for many development environments.

Application Software

NI-SCOPE provides programming interfaces, documentation, and examples for the following application development environments:

- LabVIEW
- LabWindows™/CVI™
- Measurement Studio
- Microsoft Visual C/C++
- .NET (C# and VB.NET)

Interactive Soft Front Panel and Configuration

The NI-SCOPE Soft Front Panel (SFP) allows interactive control of the PXIe-5622.

Interactive control of the PXIe-5622 was first available in NI-SCOPE SFP version 3.5. The NI-SCOPE SFP is included on the NI-SCOPE media.

NI Measurement Automation Explorer (MAX) also provides interactive configuration and test tools for the PXIe-5622. MAX is included on the NI-SCOPE media.

Power

Maximum power consumption, at highest operating temperature

+3.3 VDC	1.75 A
+12 VDC	2.25 A
Total power	32.8 W

Physical Characteristics

Dimensions	21.6 cm × 2.0 cm × 13.0 cm (8.5 in. × 0.8 in. × 5.1 in.) 3U, one slot, PXI/cPCI Module, PXI Express compatible
Weight	400 g (14.1 oz)

Environment

Maximum altitude	2,000 m (800 mbar) (at 25 °C ambient temperature)
Pollution Degree	2

Indoor use only.

Operating Environment

Ambient temperature range	0 °C to 55 °C (Tested in accordance with IEC 60068-2-1 and IEC 60068-2-2. Meets MIL-PRF-28800F Class 3 low temperature limit and MIL-PRF-28800F Class 2 high temperature limit.)
Relative humidity range	10% to 90%, noncondensing (Tested in accordance with IEC 60068-2-56.)

Storage Environment

Ambient temperature range	-40 °C to 71 °C (Tested in accordance with IEC 60068-2-1 and IEC 60068-2-2. Meets MIL-PRF-28800F Class 3 limits.)
Relative humidity range	5% to 95%, noncondensing (Tested in accordance with IEC 60068-2-56.)

Shock and Vibration

Operating shock	30 g peak, half-sine, 11 ms pulse (Tested in accordance with IEC 60068-2-27. Meets MIL-PRF-28800F Class 2 limits.)
-----------------	--

Random vibration

Operating	5 Hz to 500 Hz, 0.3 g _{rms} (Tested in accordance with IEC 60068-2-64.)
Nonoperating	5 Hz to 500 Hz, 2.4 g _{rms} (Tested in accordance with IEC 60068-2-64. Test profile exceeds the requirements of MIL-PRF-28800F, Class 3.)

Compliance and Certifications

Safety

This product is designed to meet the requirements of the following electrical equipment safety standards for measurement, control, and laboratory use:

- IEC 61010-1, EN 61010-1
- UL 61010-1, CSA C22.2 No. 61010-1



Note For UL and other safety certifications, refer to the product label or the [Online Product Certification](#) section.

Electromagnetic Compatibility

This product meets the requirements of the following EMC standards for electrical equipment for measurement, control, and laboratory use:

- EN 61326-1 (IEC 61326-1): Class A emissions; Basic immunity
- EN 55011 (CISPR 11): Group 1, Class A emissions
- EN 55022 (CISPR 22): Class A emissions
- EN 55024 (CISPR 24): Immunity
- AS/NZS CISPR 11: Group 1, Class A emissions
- AS/NZS CISPR 22: Class A emissions
- FCC 47 CFR Part 15B: Class A emissions
- ICES-001: Class A emissions



Note In the United States (per FCC 47 CFR), Class A equipment is intended for use in commercial, light-industrial, and heavy-industrial locations. In Europe, Canada, Australia, and New Zealand (per CISPR 11), Class A equipment is intended for use only in heavy-industrial locations.



Note Group 1 equipment (per CISPR 11) is any industrial, scientific, or medical equipment that does not intentionally generate radio frequency energy for the treatment of material or inspection/analysis purposes.



Note For EMC declarations, certifications, and additional information, refer to the [Online Product Certification](#) section.

CE Compliance

This product meets the essential requirements of applicable European Directives, as follows:

- 2014/35/EU; Low-Voltage Directive (safety)
- 2014/30/EU; Electromagnetic Compatibility Directive (EMC)

Online Product Certification

Refer to the product Declaration of Conformity (DoC) for additional regulatory compliance information. To obtain product certifications and the DoC for this product, visit ni.com/certification, search by model number or product line, and click the appropriate link in the Certification column.

Environmental Management

NI is committed to designing and manufacturing products in an environmentally responsible manner. NI recognizes that eliminating certain hazardous substances from our products is beneficial to the environment and to NI customers.

For additional environmental information, refer to the *Minimize Our Environmental Impact* web page at ni.com/environment. This page contains the environmental regulations and directives with which NI complies, as well as other environmental information not included in this document.

Waste Electrical and Electronic Equipment (WEEE)



EU Customers At the end of the product life cycle, all NI products must be disposed of according to local laws and regulations. For more information about how to recycle NI products in your region, visit ni.com/environment/weee.

电子信息产品污染控制管理办法（中国 RoHS）



中国客户 National Instruments 符合中国电子信息产品中限制使用某些有害物质指令 (RoHS)。关于 National Instruments 中国 RoHS 合规性信息，请登录 ni.com/environment/rohs_china。(For information about China RoHS compliance, go to ni.com/environment/rohs_china.)

Information is subject to change without notice. Refer to the *NI Trademarks and Logo Guidelines* at ni.com/trademarks for information on NI trademarks. Other product and company names mentioned herein are trademarks or trade names of their respective companies. For patents covering NI products/technology, refer to the appropriate location: **Help>Patents** in your software, the `patents.txt` file on your media, or the *National Instruments Patent Notice* at ni.com/patents. You can find information about end-user license agreements (EULAs) and third-party legal notices in the `readme` file for your NI product. Refer to the *Export Compliance Information* at ni.com/legal/export-compliance for the NI global trade compliance policy and how to obtain relevant HTS codes, ECCNs, and other import/export data. NI MAKES NO EXPRESS OR IMPLIED WARRANTIES AS TO THE ACCURACY OF THE INFORMATION CONTAINED HEREIN AND SHALL NOT BE LIABLE FOR ANY ERRORS. U.S. Government Customers: The data contained in this manual was developed at private expense and is subject to the applicable limited rights and restricted data rights as set forth in FAR 52.227-14, DFAR 252.227-7014, and DFAR 252.227-7015.